

suit'd[®]suits

wall furnishing.



Brochure Cover Model S.1 / 1930
Autumn / Fall 2018



www.suitedsuits.com



About

Dutch designbrand Suit'd[®] Suits (pronounce: 'sooted soots') offers various self-designed productmodels to style build-in power outlets, light knobs and related wiring parts to the interior indoors. For a well deserved *Finishing Touch*.

Use of Natural Materials

Equal to what people desire to add to their interior, Suit'd[®] Suits offer its products with real natural materials from premium suppliers. Bamboo, architectural wood-types, handpoured ceramics and crystal.

Available in different colors and designs, crafted with devotion by local craftsmen and the top of the industry.

Original Designs Inspire

From the early developments in 2010 and making its market entry in 2012, Suit'd[®] Suits became the first brand who made it possible by its models to allow interior styling to build-in power outlets and related parts. Nowadays the brand has a unique position by making the translation between ancient arts and crafts, design and modern consumer goods.





“This Cover Model is a catchy answer to ban plastic surfaces from power outlets and related parts from the interior. With only the functional element visible – the rest is hidden inside the cover, these products allow interior styling even to the smallest detail.”

Available materials:

- **CNC cutted wooden surface (visible on the sides)**

Origin: The Netherlands
 Maker: Plexwood Services
 Design: Birch + Birch, Meranti + Ocoumé.

- **Handmade ceramic surface (visible on the sides)**

Origin: The Netherlands
 Maker: Montagne Aardewerk
 Design: Uni colour, hand painted in various styles & techniques.



Pre-assembled inner adhesive doublesided tape for fixation onto the inner Berker components

*Image: Genuine hand painted Delft Blue by Dutch Master Painter mr. Paul Bartels.
 Note: The Delft Blue arts & crafts is official protected Dutch cultural heritage. Suit'd® Suits is proud to offer this typical crafting technique in its product lines. Carefully re-developed for this product application with its partners.*

Single size
L 80 x W 80 x H 14 mm

**S.1 /
 1930
 wood**

Double size
L 151 x W 80 x H 14 mm

Trippel size
L 222 x W 80 x H 14 mm

Quadrupel size
L 293 x W 80 x H 14 mm

**S.1 /
 1930
 ceramics**

Single size
L 83 x W 83 x H 14 mm

Double size
L 156 x W 83 x H 14 mm

Specific information about (tailor-made) products & the possibilities, lead time or price requests: info@suitsd.com

– This particular product line (Cover Model S.1/1930) is directly applicable on berker S.1 outlets, dimmers and the 1930 Series light switch components. Suit'd® Suits by Suit'd Suits B.V. i.o. is a recognized partner from Hager. Berker wiring accessories are supplied by Hager Netherlands.

– SUIT'D SUITS is a registered trademark. Our products and models are registered and protected.

Atelier address: Hofwijckplein 64, 2515 RL, Den Haag, NLD / Registratiecode Chamber of Commerce: 53233727 / website: www.suitsd.com

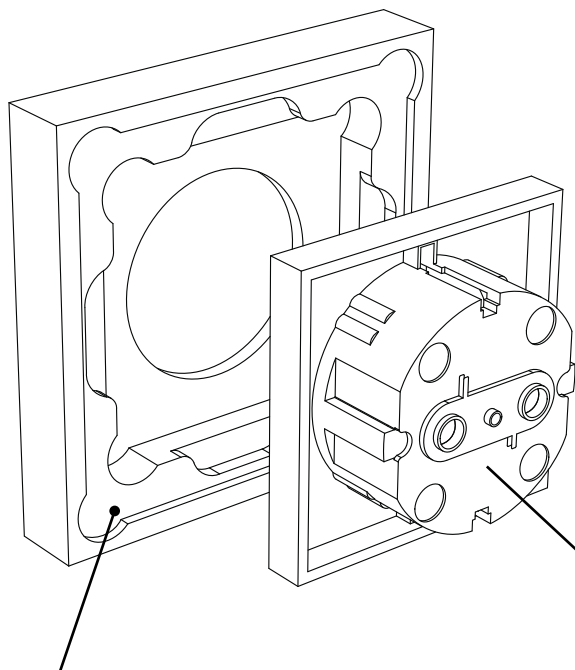

- **Wooden and ceramic surfaces**
Various designs and models available
- **Easy application with the inner tape**
Direct fixation onto the plastic inner parts

Available Models

Wood

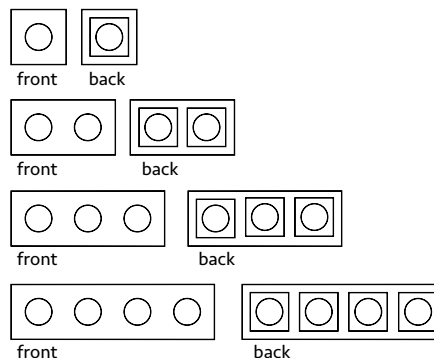

Ceramics

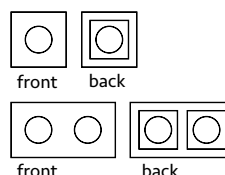

Applicable on Type C, E, F wiring accessories from Berker S.1: power outlets, dimmer. Additional suitable onto the 1930 Series light knobs.
Provided by Hager Netherlands.
See: Hager.com for further info.



Specific information about (tailor-made) products & the possibilities, lead time or price requests: info@suitedsuits.com

This particular product line (Cover Model S.1/1930) is directly applicable on berker S.1 outlets, dimmers and the 1930 Series light switch components. Suit'd® Suits by Suit'd Suits B.V. i.o. is a recognized partner from Hager. Berker wiring accessories are supplied by Hager Netherlands.









SUIT'D SUITS is a registered trademark. Our products and models are registered and protected.

Atelier address: Hofwijckplein 64, 2515 RL, Den Haag, NLD / Registrationcode Chamber of Commerce: 53233727 / website: www.suitedsuits.com

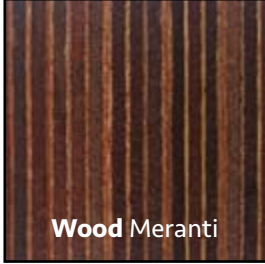

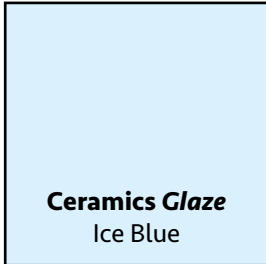
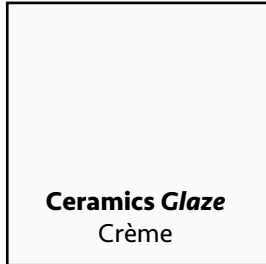
Options for wood and ceramics

High-end Plexwood[®] woodmaterials
CNC cutted and traditional Dutch hand-
made ceramics and crafting techniques.

<p>Meranti</p> 	 <p>Wood Birch</p>	 <p>Wood Meranti</p>		
	<p><i>Similar to the Berker white colour components</i></p> <p>Ceramics Glaze White</p>	<p><i>Similar to the Berker black colour components</i></p> <p>Ceramics Glaze Black</p>		
<p><i>Ready to add your own wall paint</i></p> <p>Ceramics Re-paintable</p>	 <p>Ceramics Glaze Pistache</p>	 <p>Ceramics Glaze Abricot</p>	 <p>Ceramics Glaze Ice Blue</p>	 <p>Ceramics Glaze Crème</p>
				<p>Something else in your mind? The ceramic colours and designs can be customised.</p> <p>E-mail us ></p>
<p><i>Suit'd[®] Suits offers Genuine Delft Blue, handcrafted by Dutch artisans in The Netherlands.</i></p>				

Specific information about (tailor-made) products & the possibilities, lead time or price requests: info@suitedsuits.com

– This particular product line (Cover Model S.1/1930) is directly applicable on berker S.1 outlets, dimmers and the 1930 Series light switch components. Suit'd[®] Suits by Suit'd Suits B.V. i.o. is a recognized partner from Hager. Berker wiring accessories are supplied by Hager Netherlands.

– SUIT'D SUITS is a registered trademark. Our products and models are registered and protected.

Atelier address: Hofwijckplein 64, 2515 RL, Den Haag, NLD / Registrationcode Chamber of Commerce: 53233727 / website: www.suitedsuits.com